



# **CUSTOM ENAMELWARE**

## **DIELINES**



# CUSTOM ENAMELWARE

## SPECIFICATIONS

1. Open the file in Adobe Illustrator or any other vector software
2. Fonts must be converted to curves.
3. Avoid gradient and transparency
4. Save the graphics as a vector in .pdf, .eps or .ai file



**YOUR  
COMPANY  
NAME**

**9 CM CANISTER  
DIELINE**

scale 1:1

**DIMENSIONS**

*height*    100mm    3,9 inch

*diameter*    90mm    3,5 inch

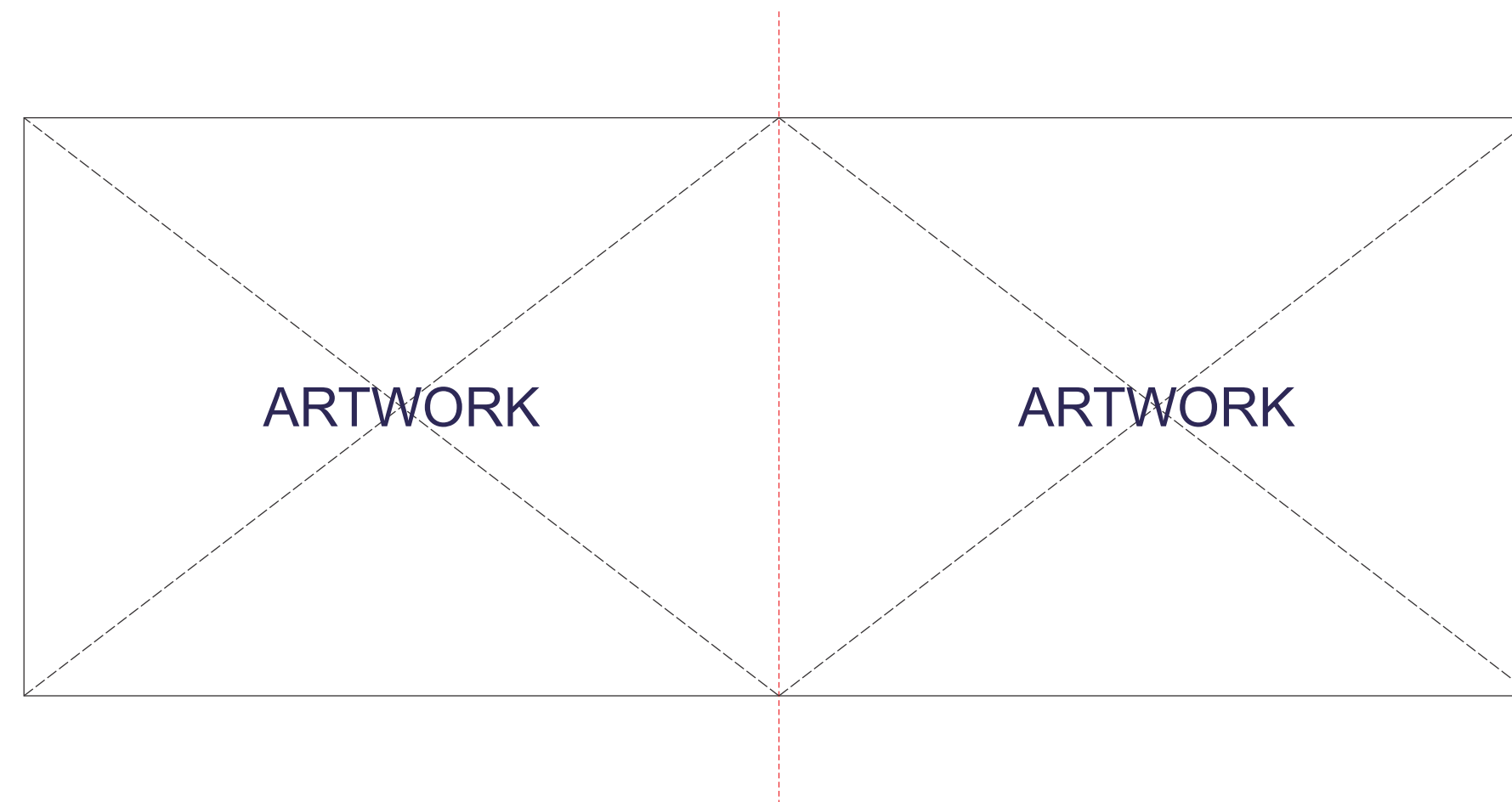

**1/15**



**YOUR  
COMPANY  
NAME**

**11 CM CANISTER  
DIELINE**

scale 1:1

**DIMENSIONS**

*height* 124.5mm 4,9 inch

*diameter* 114.3 mm 4,5 inch

**2/15**

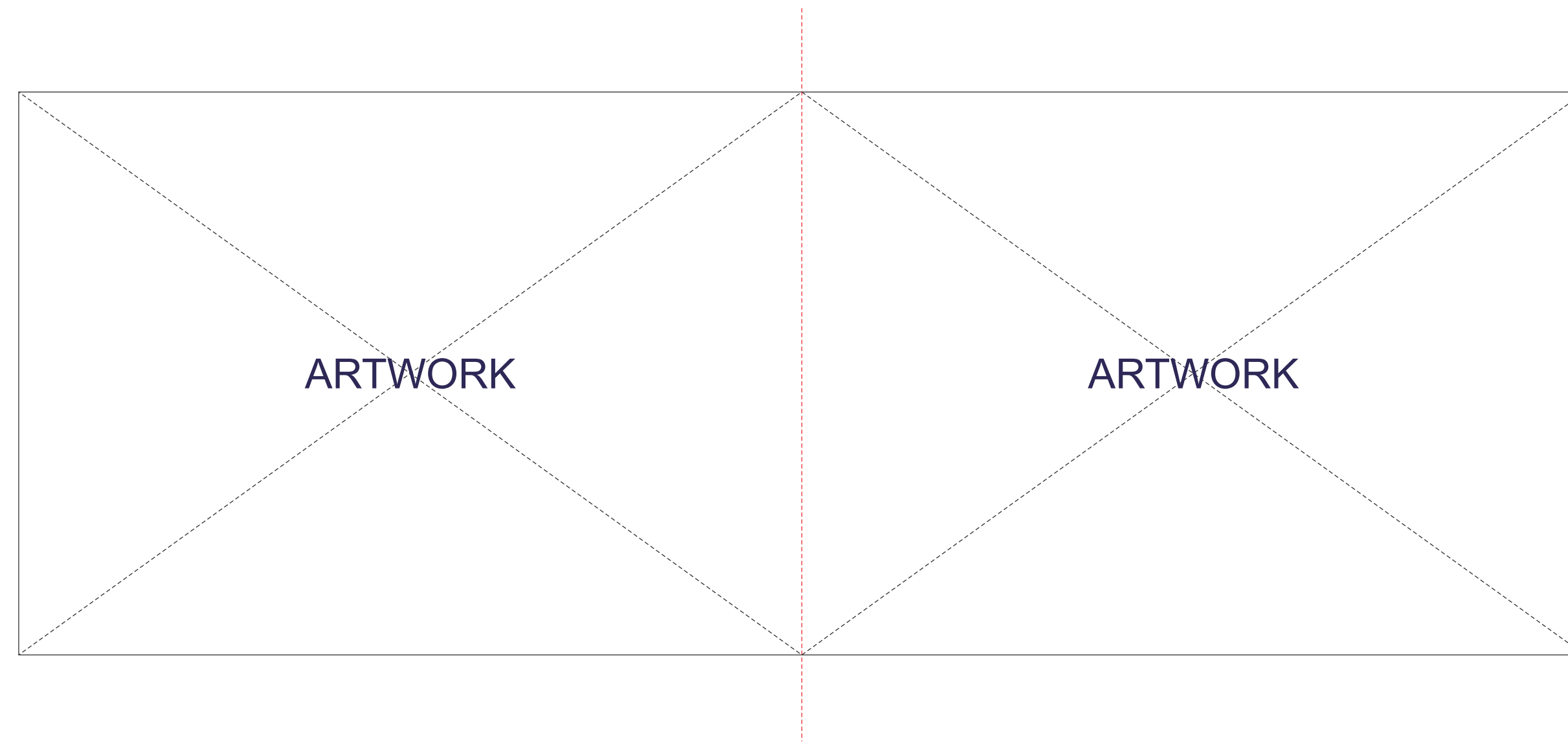

from below



**YOUR  
COMPANY  
NAME**

**14 CM CANISTER  
DIELINE**

scale 1:1

**DIMENSIONS**

*height* 149.9mm 5.9 inch

*diameter* 139.7mm 5.5 inch

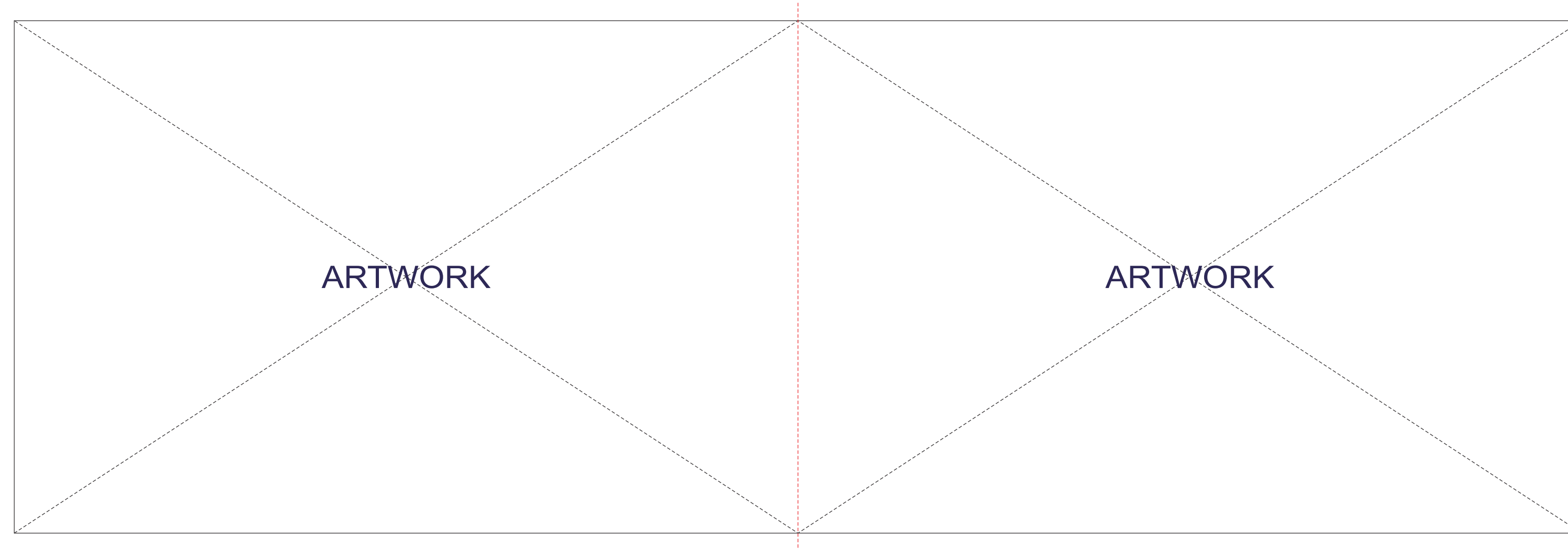

**3/15**



**YOUR  
COMPANY  
NAME**

**17 CM CANISTER  
DIELINE**  
scale 1:1

**DIMENSIONS**  
*height* 175.3mm 6.9 inch  
*diameter* 165.1mm 6,5 inch

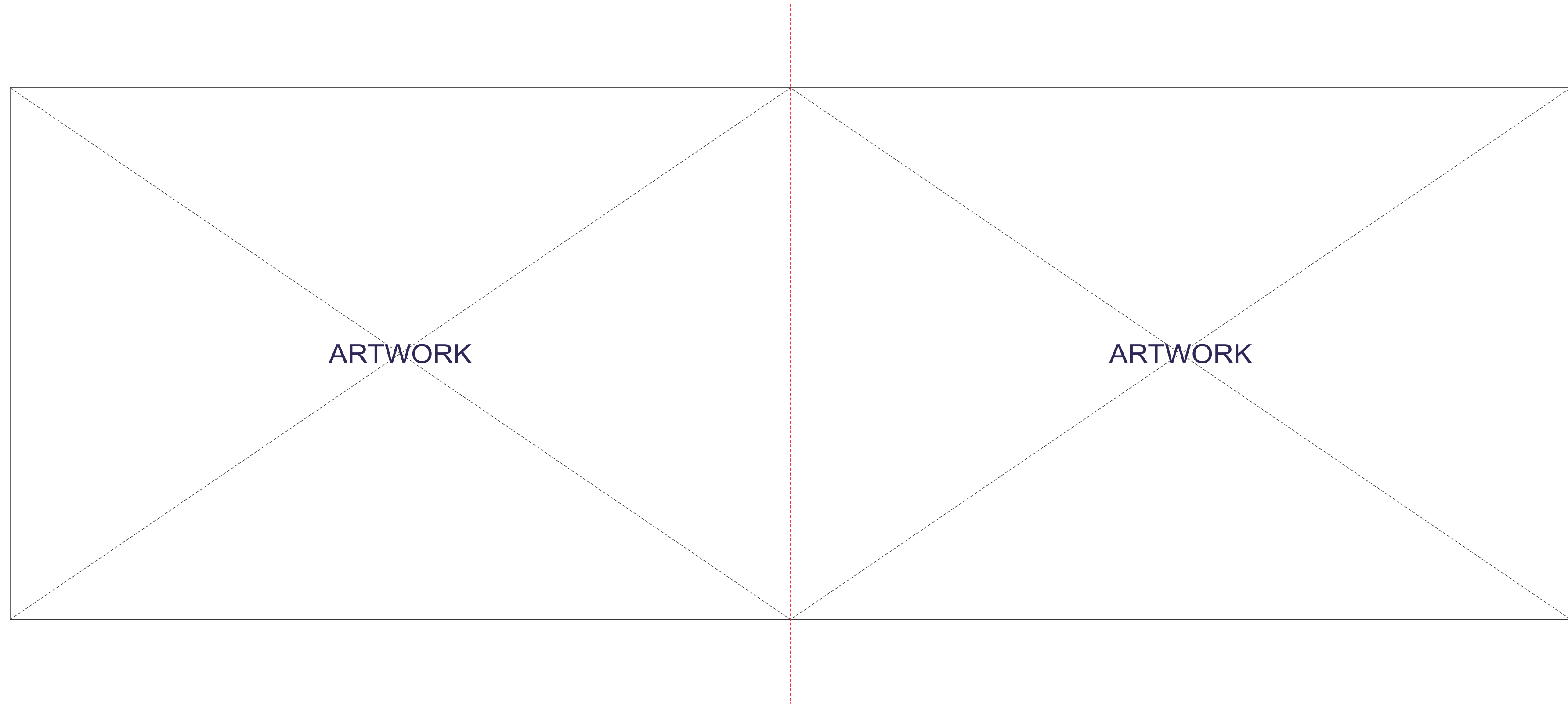



YOUR COMPANY NAME

7 CM MUG DIELINE

scale 1:1

DIMENSIONS

height 60 mm 2.4 inch

diameter 70 mm 2.8 inch

capacity 5oz

5/15

from above

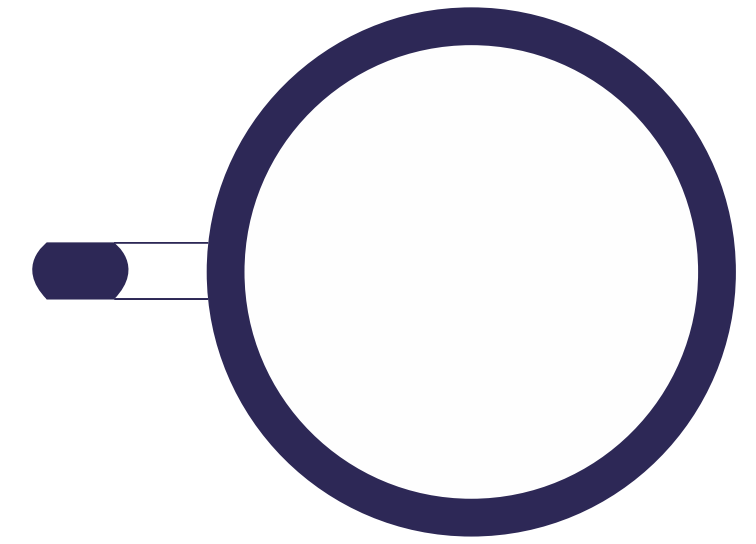

from below

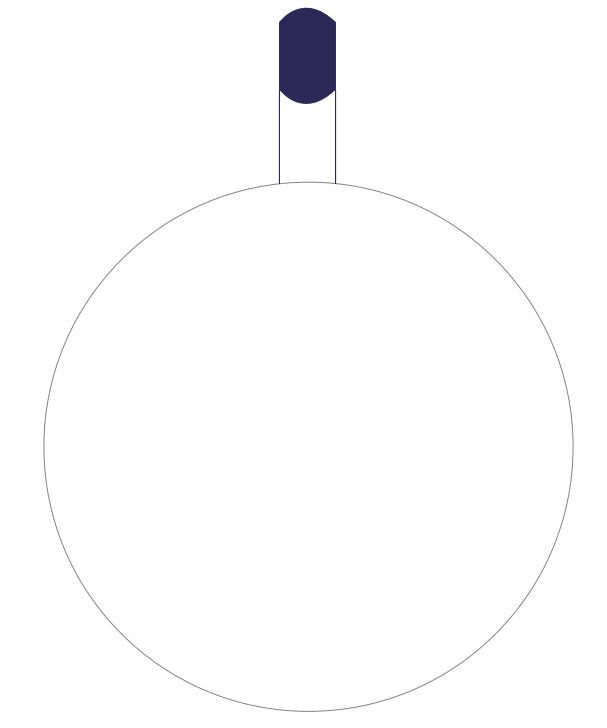
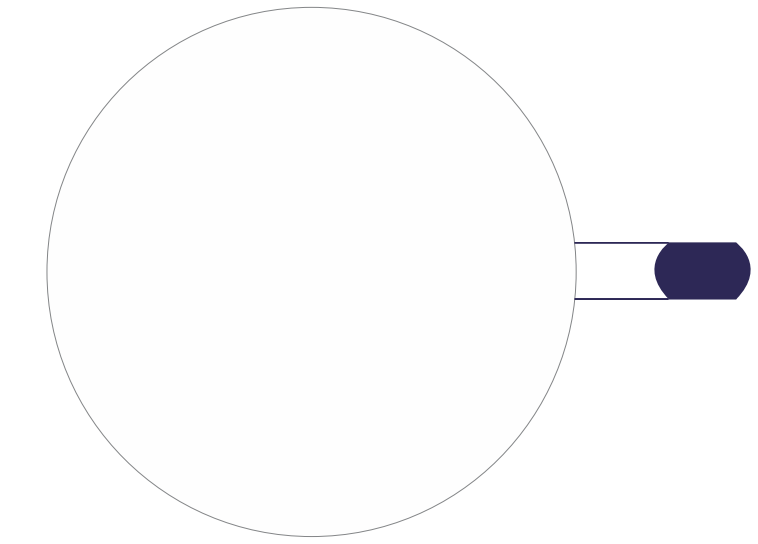

side A

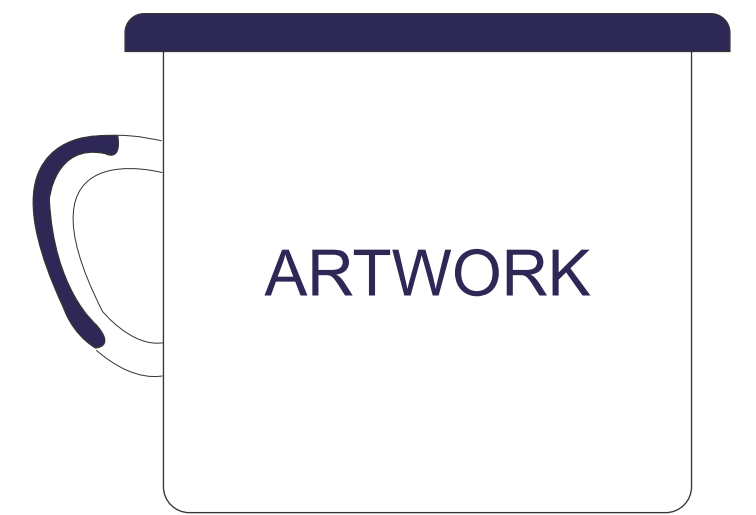

side B

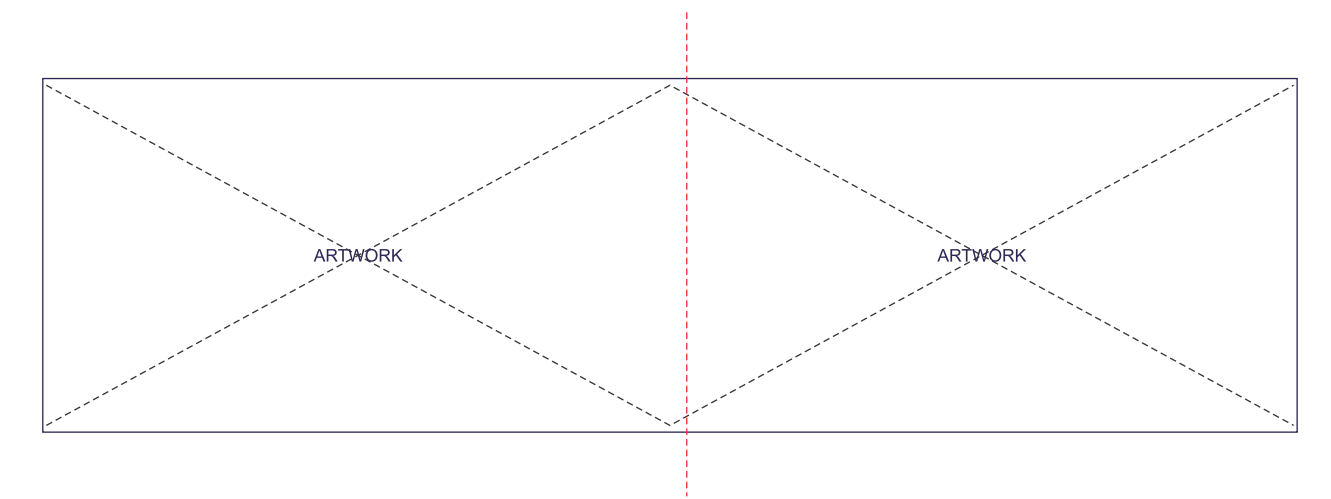
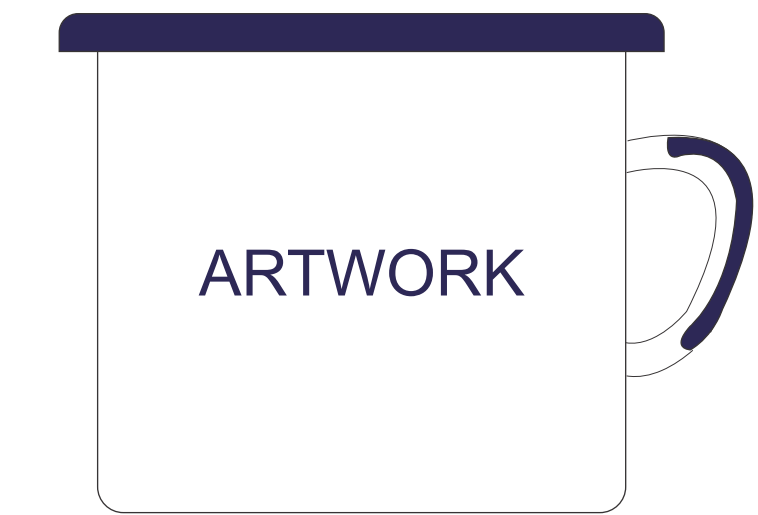



YOUR  
COMPANY  
NAME

8CM MUG  
DIELINE

scale 1:1

DIMENSIONS

height 80 mm 3.1 inch

diameter 90 mm 3.5 inch

capacity 11 oz

6/15

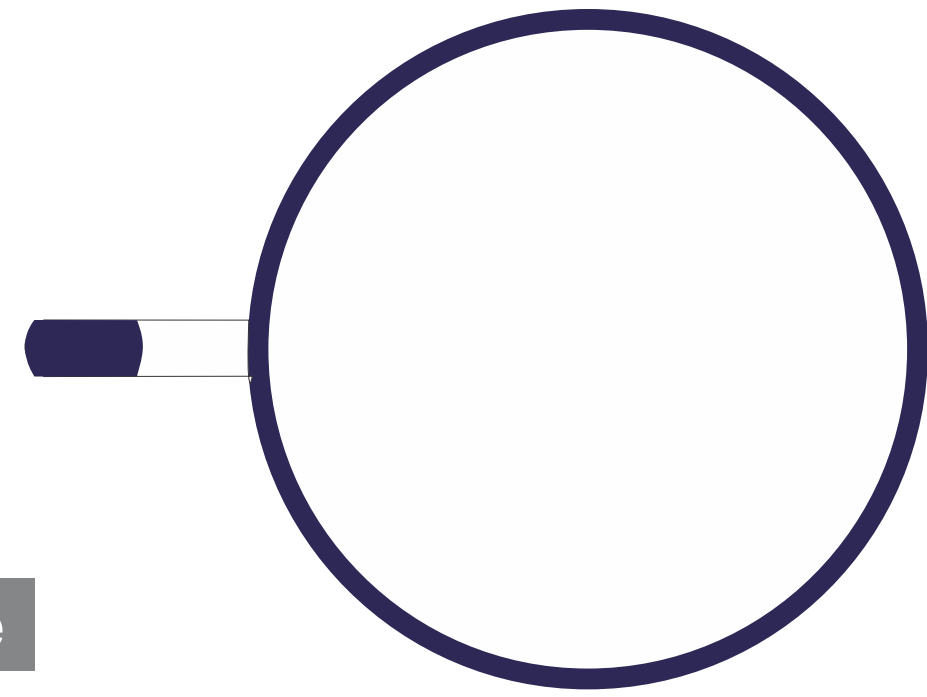

from above

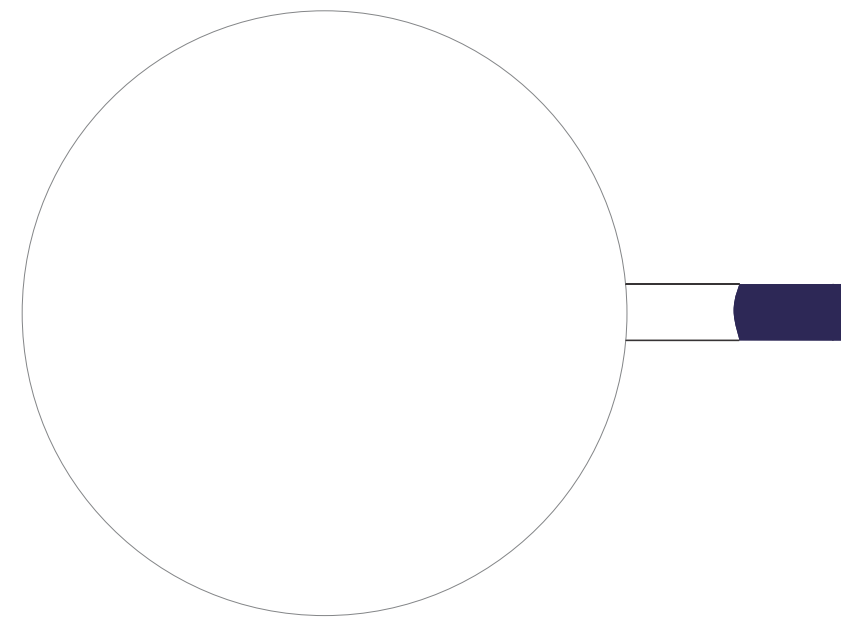

from below

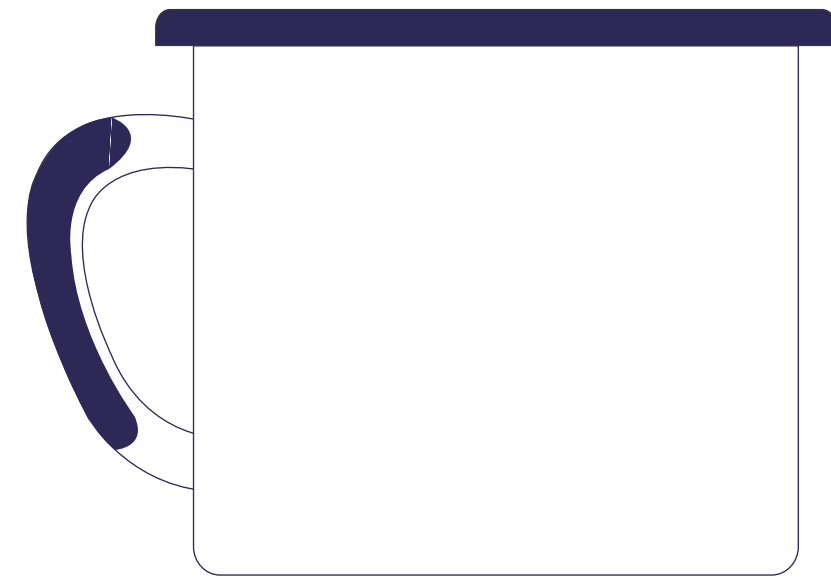
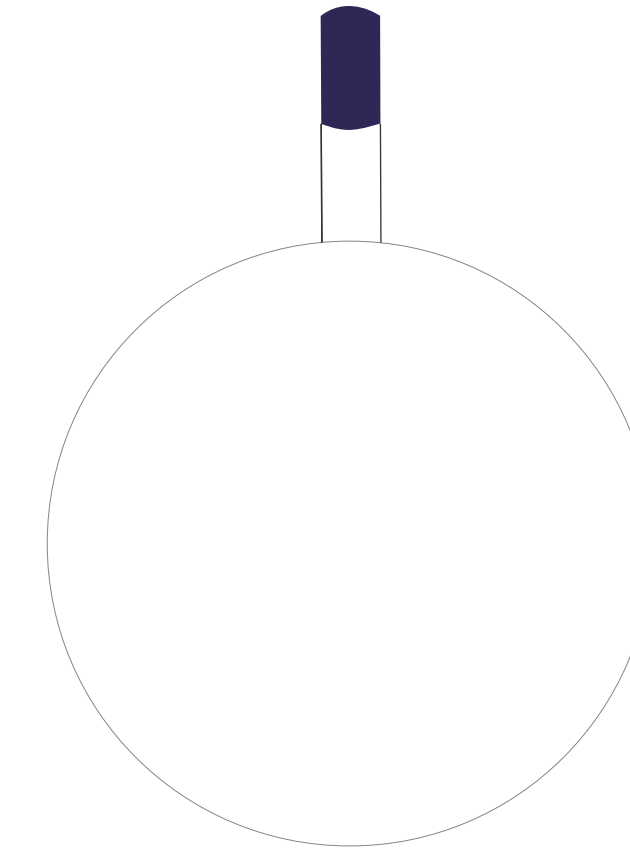

side A



side B

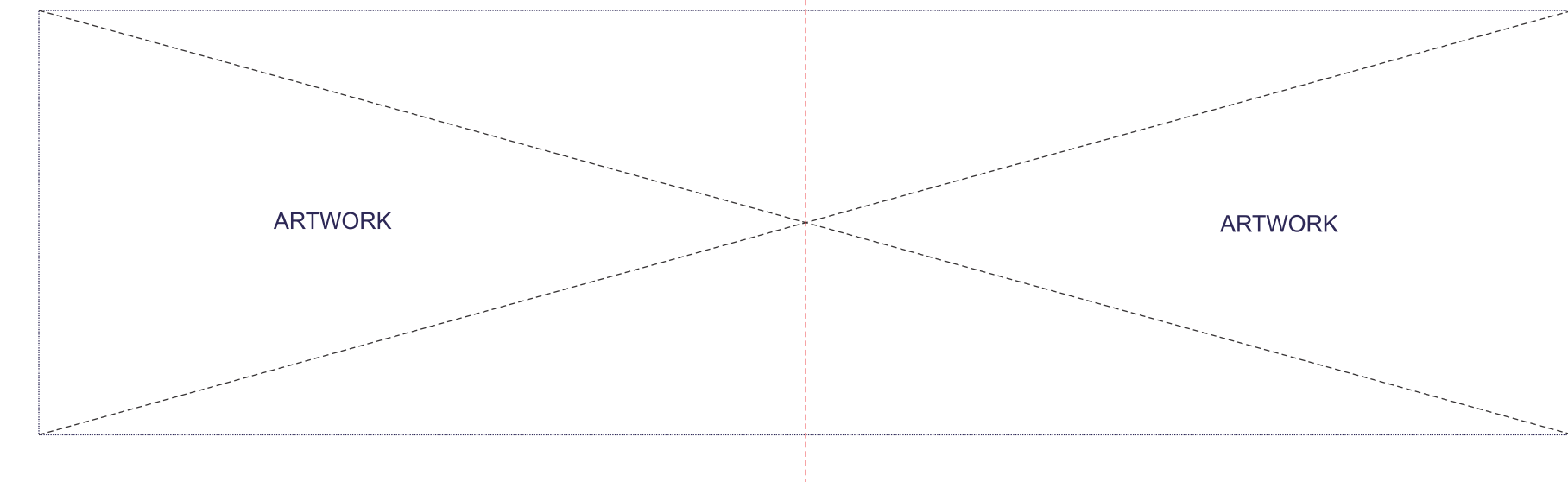





YOUR  
COMPANY  
NAME

9CM MUG  
DIELINE

scale 1:1

DIMENSIONS

height 90 mm 3.5 inch

diameter 90 mm 3.5 inch

capacity 16 oz

7/15

from above

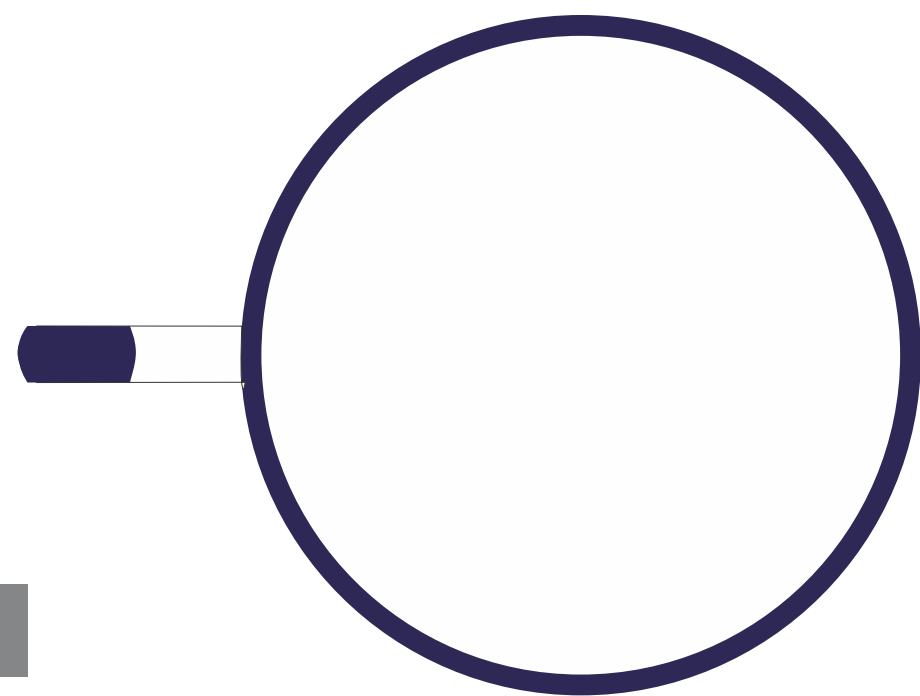

from below

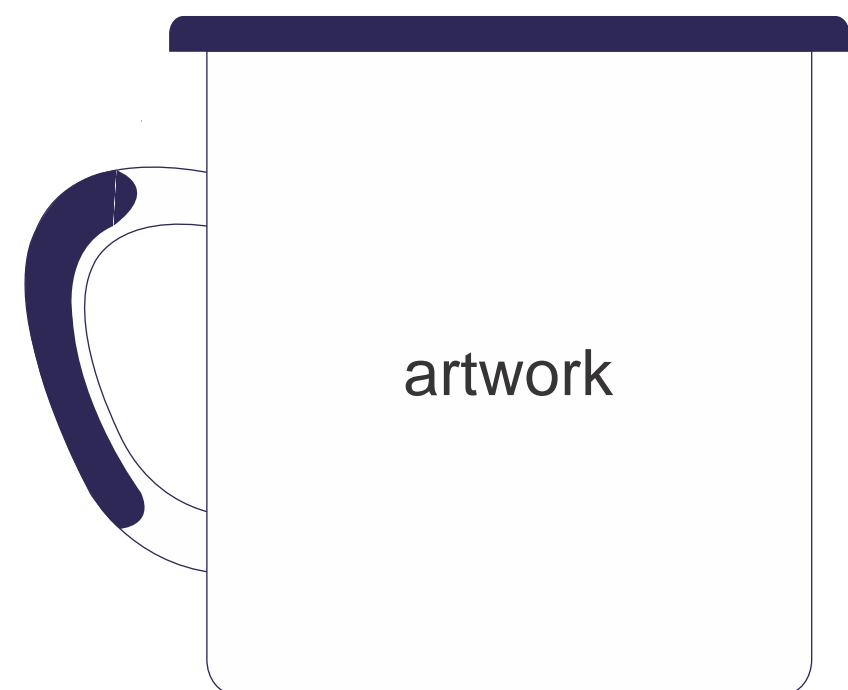
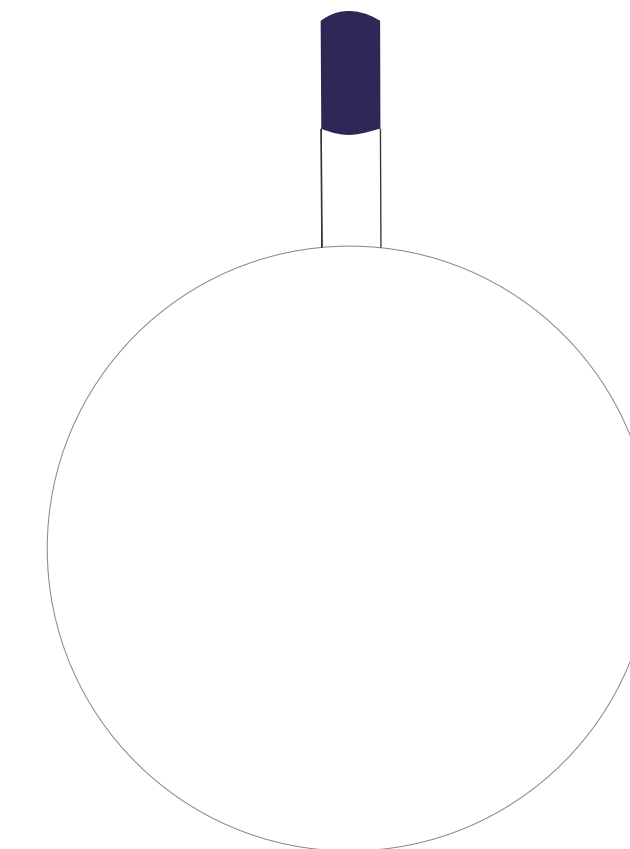
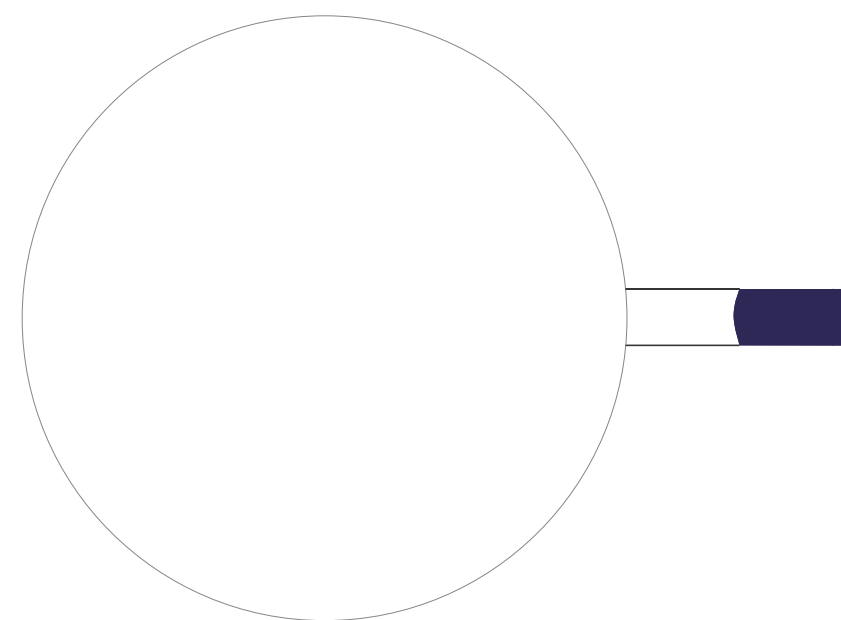

side A

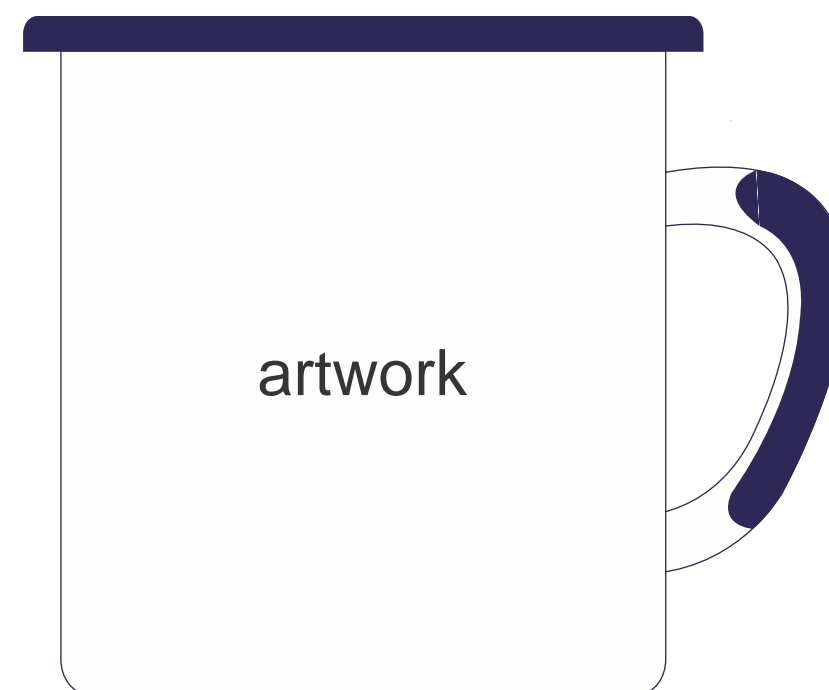

side B

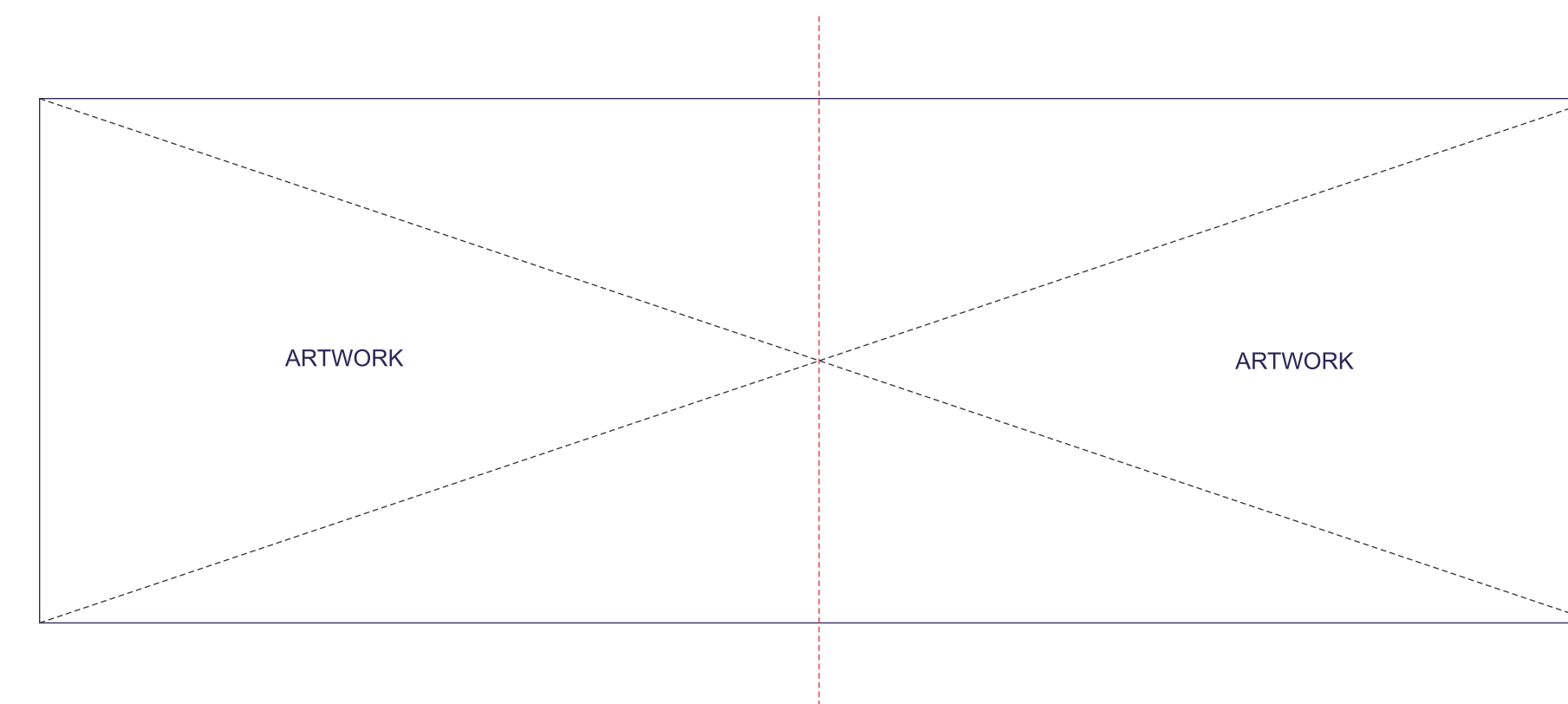



**YOUR  
COMPANY  
NAME**

**11 CM MUG  
DIELINE**

scale 1:1

**DIMENSIONS**

*height* 90 mm 3.5 inch

*diameter* 112 mm 4.4 inch

*capacity* 22 oz

**8/15**

from above

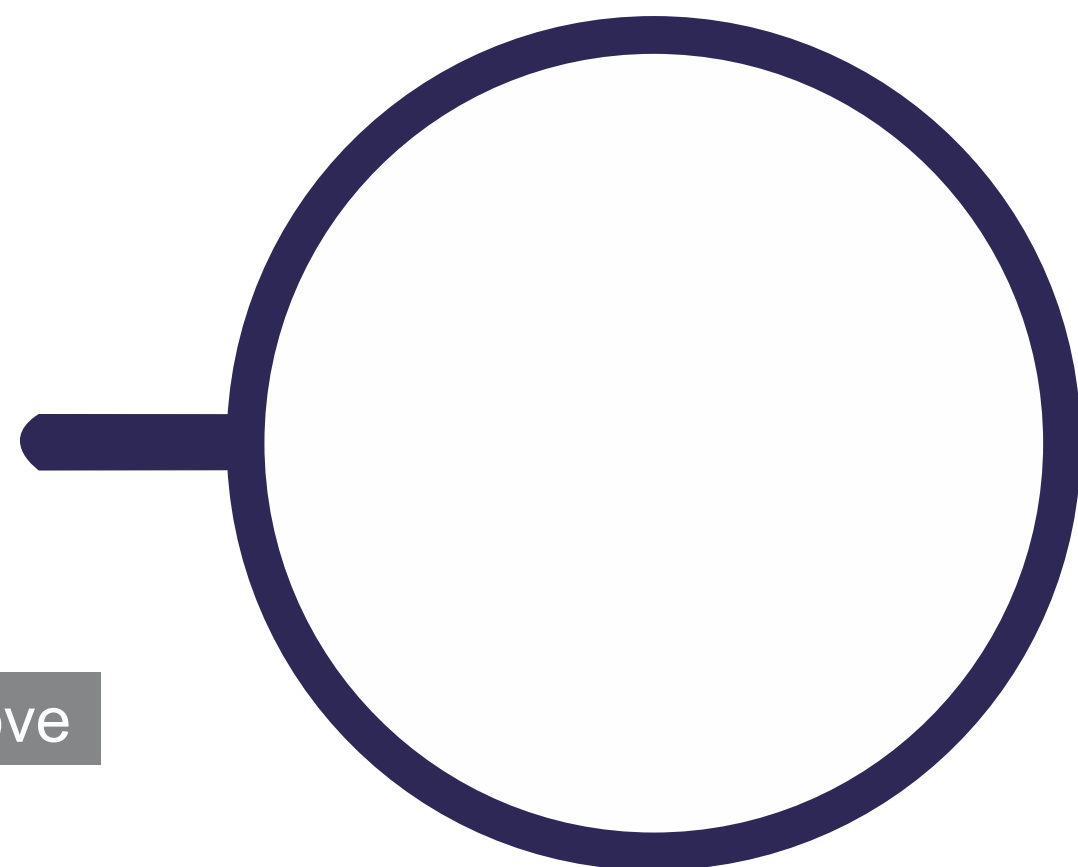

from below

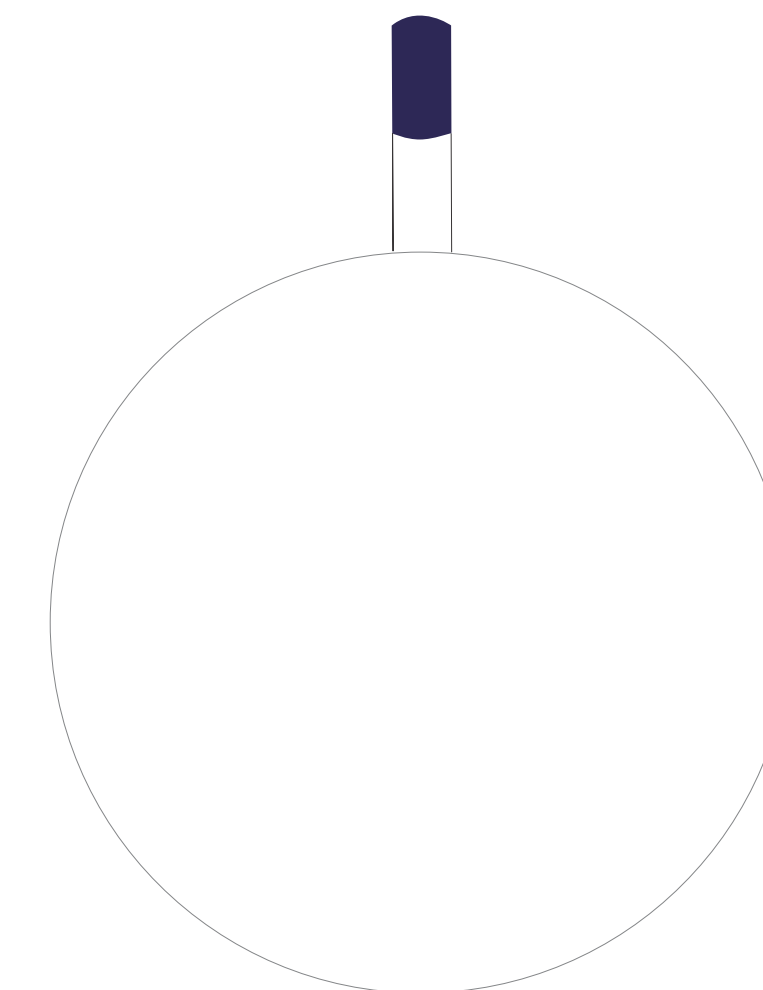
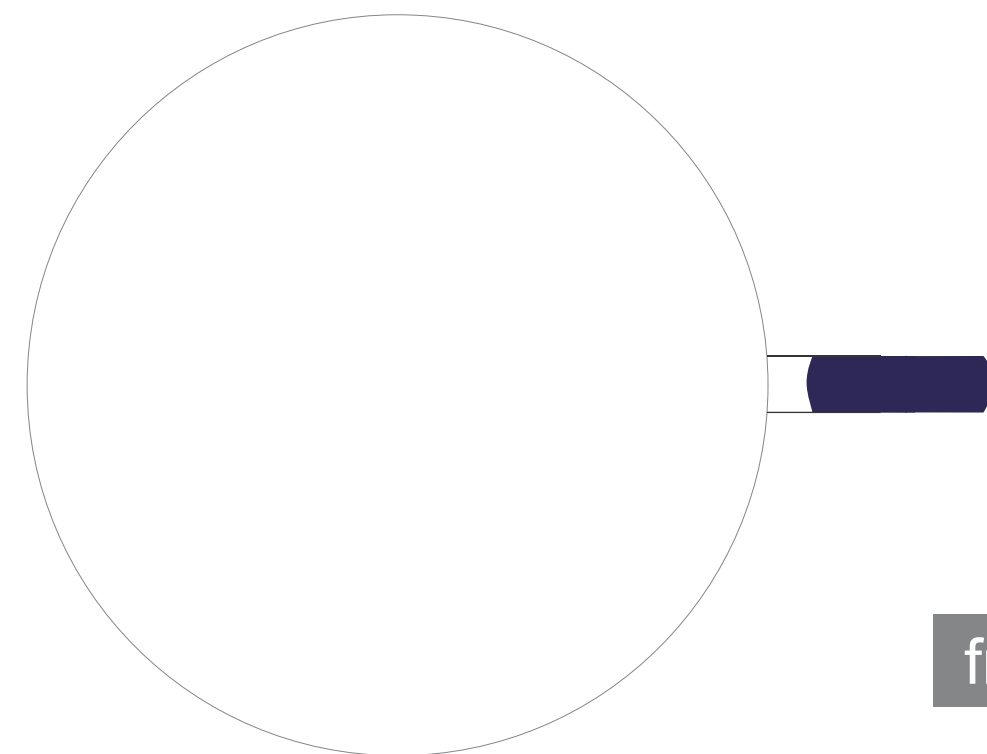

side A



side B

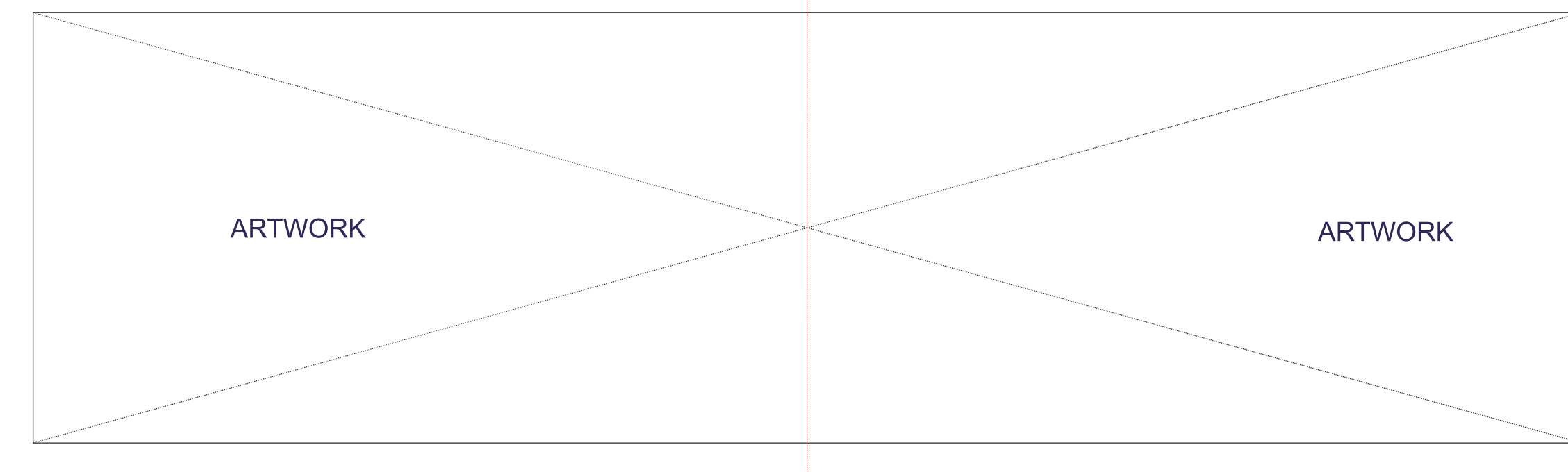



**YOUR  
COMPANY  
NAME**

**10 CM TUMBLER  
DIELINE**

scale 1:1

**DIMENSIONS**

*height* 100mm 3.9 inch

*diameter* 90mm 3.5 inch

*capacity* 10.5 oz

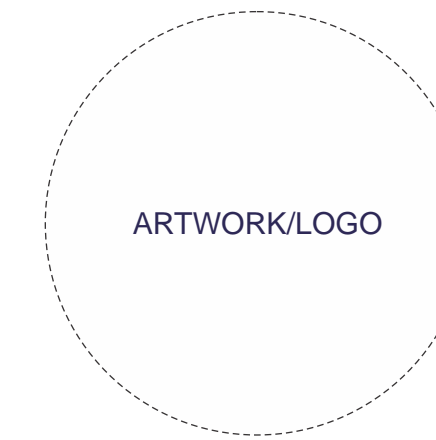

**9/15**



**YOUR  
COMPANY  
NAME**

**16 CM  
CHARGER PLATE  
DIELINE**

scale 1:1

**DIMENSIONS**

*height* 15mm 0.6 inch

*diameter* 160mm 6.3 inch

**10/15**

from above

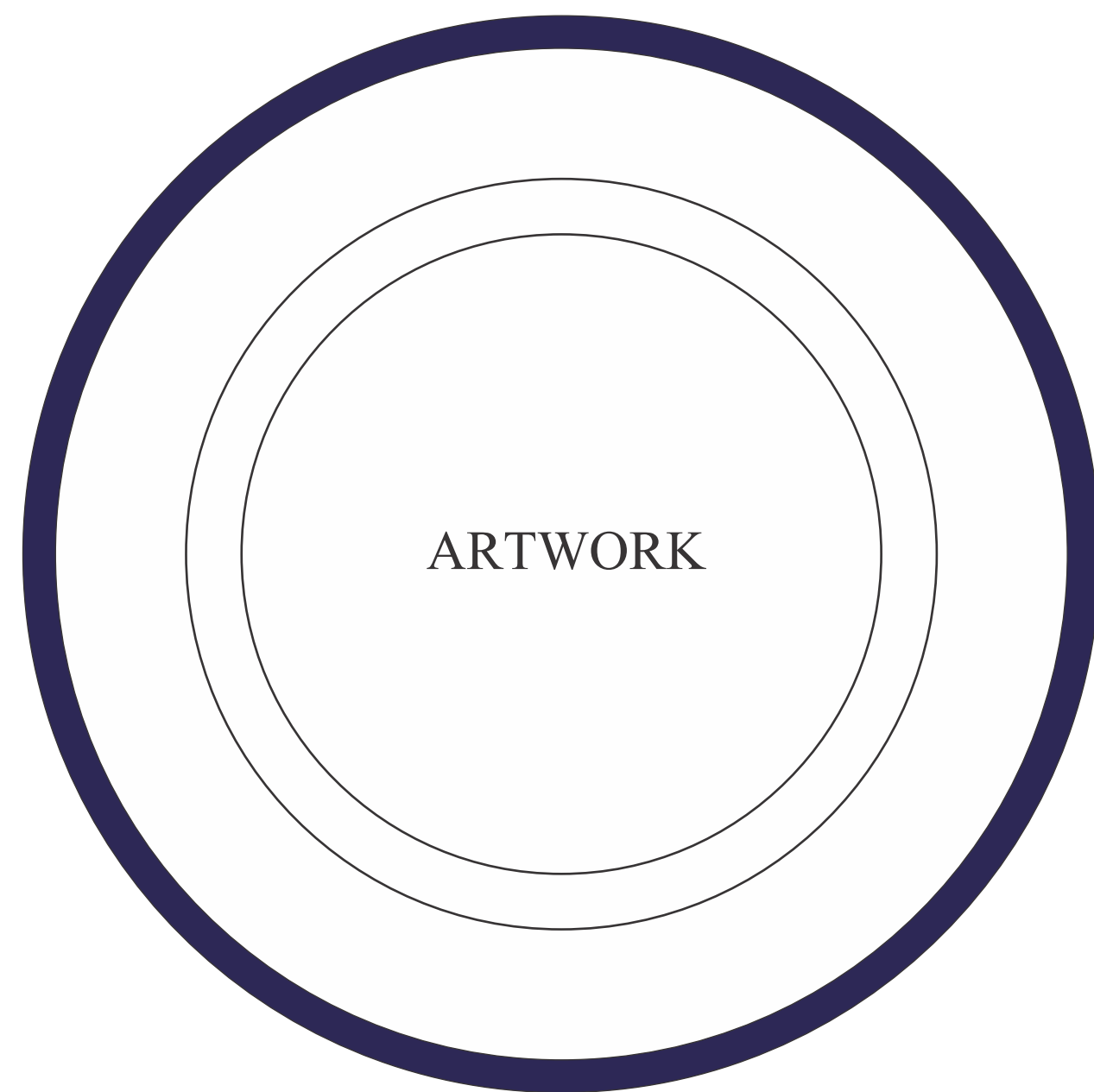

from below

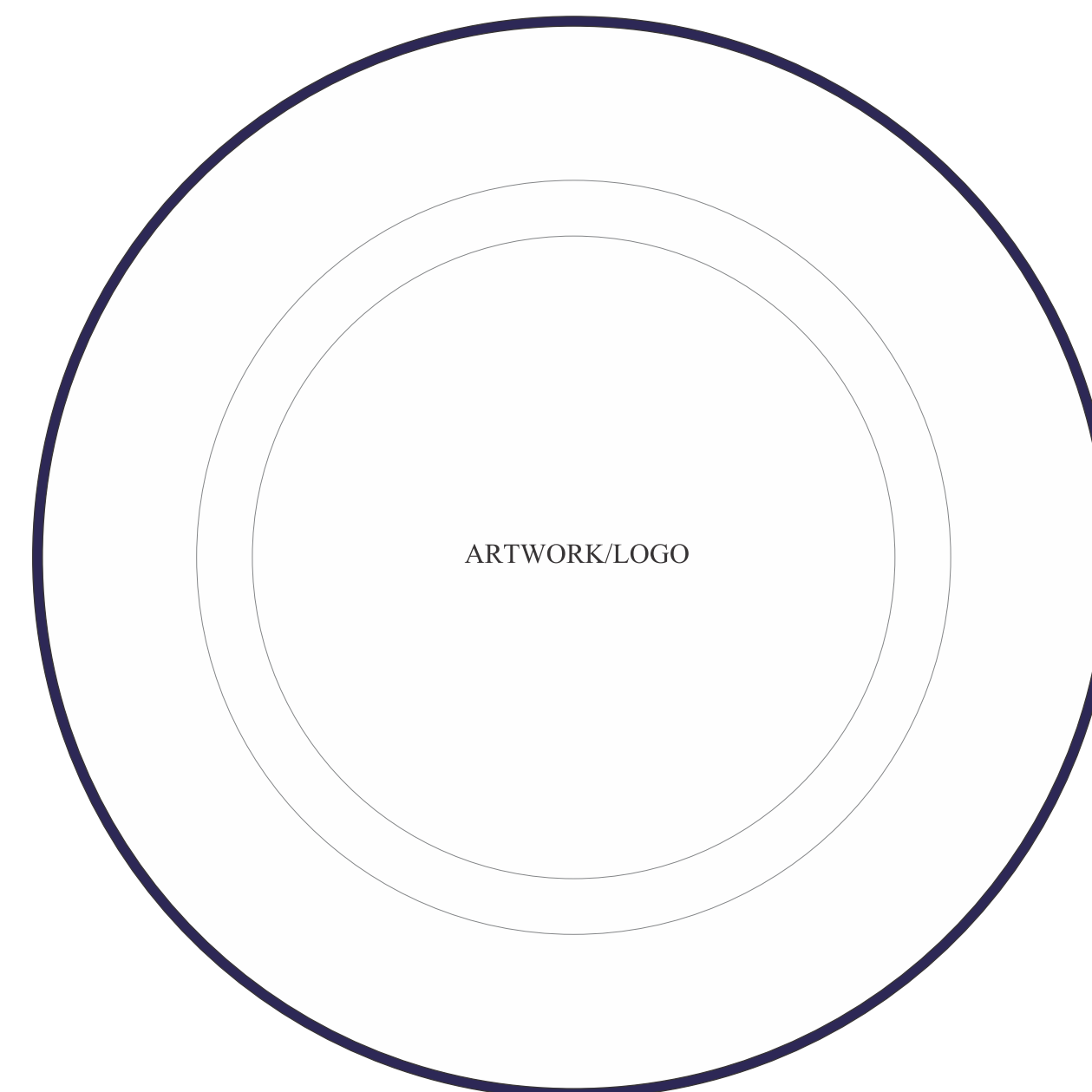



**YOUR  
COMPANY  
NAME**

**20 CM  
CHARGER PLATE  
DIELINE**

scale 1:1

**DIMENSIONS**

*height*    15mm    0.6 inch

*diameter*    200mm    7.9 inch

from above

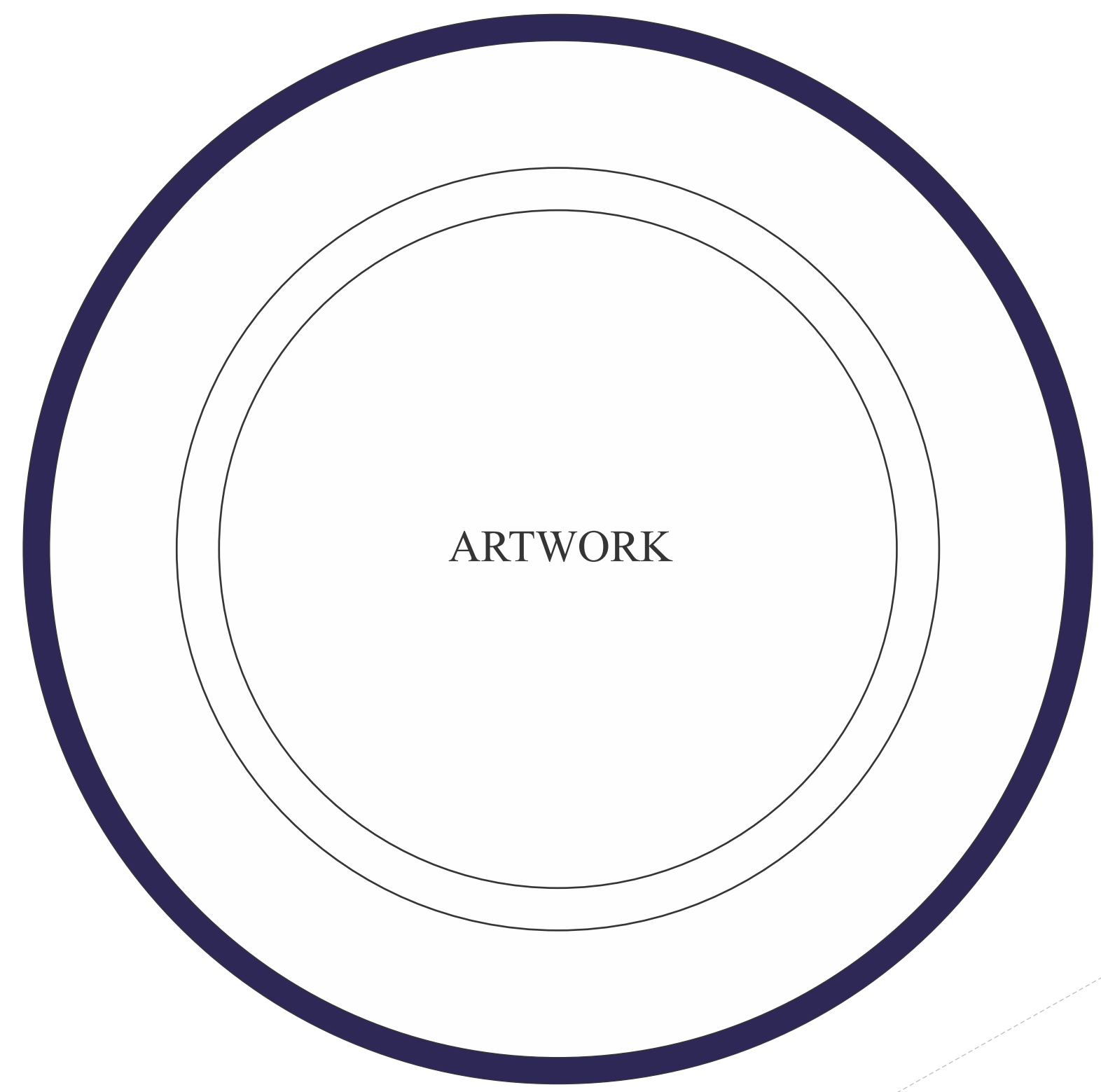

from below





YOUR  
COMPANY  
NAME

26 CM  
CHARGER PLATE  
DIELINE

scale 1:1

DIMENSIONS

height 20mm 0.8 inch

diameter 260mm 10.2 inch

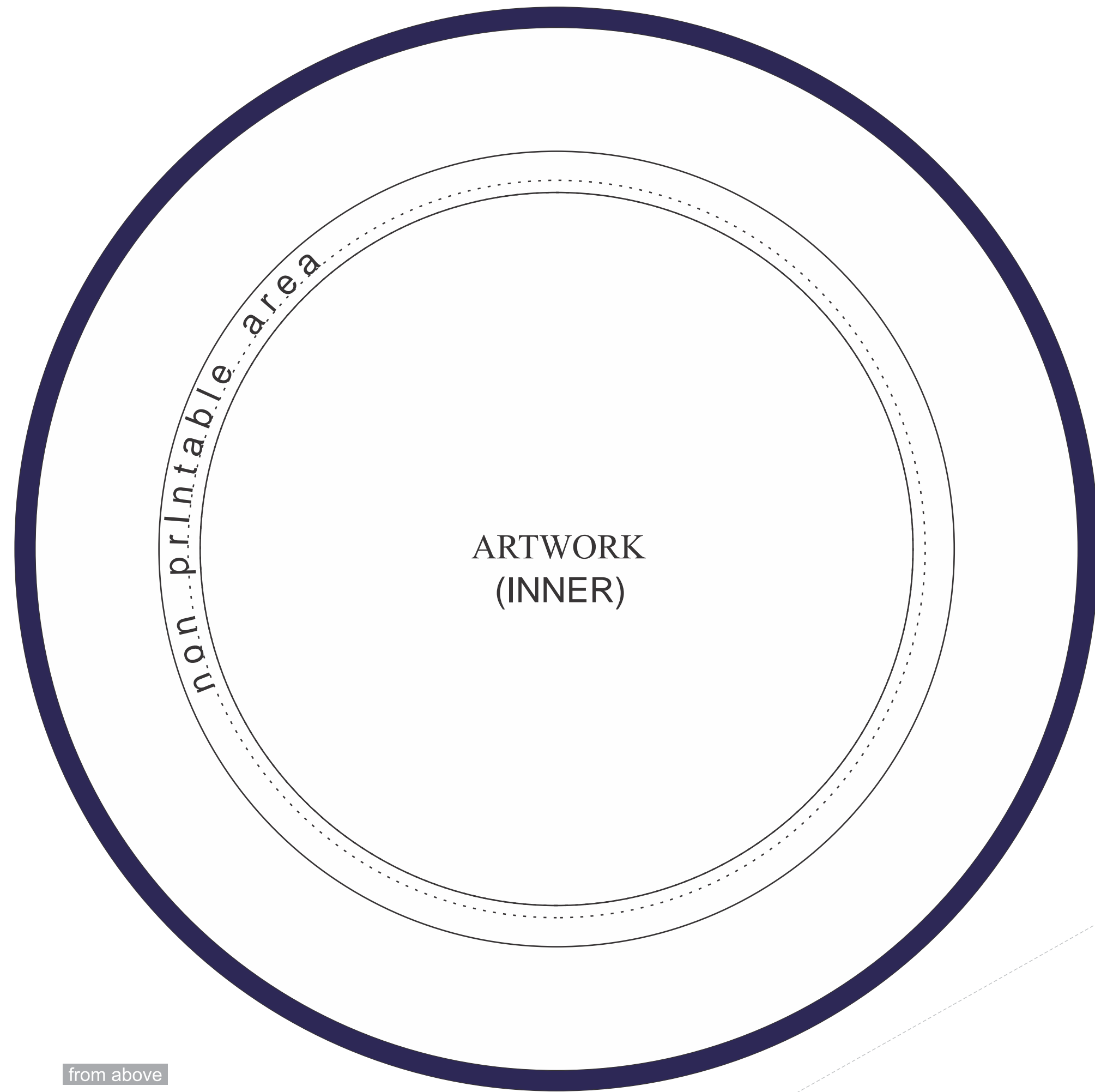

from above

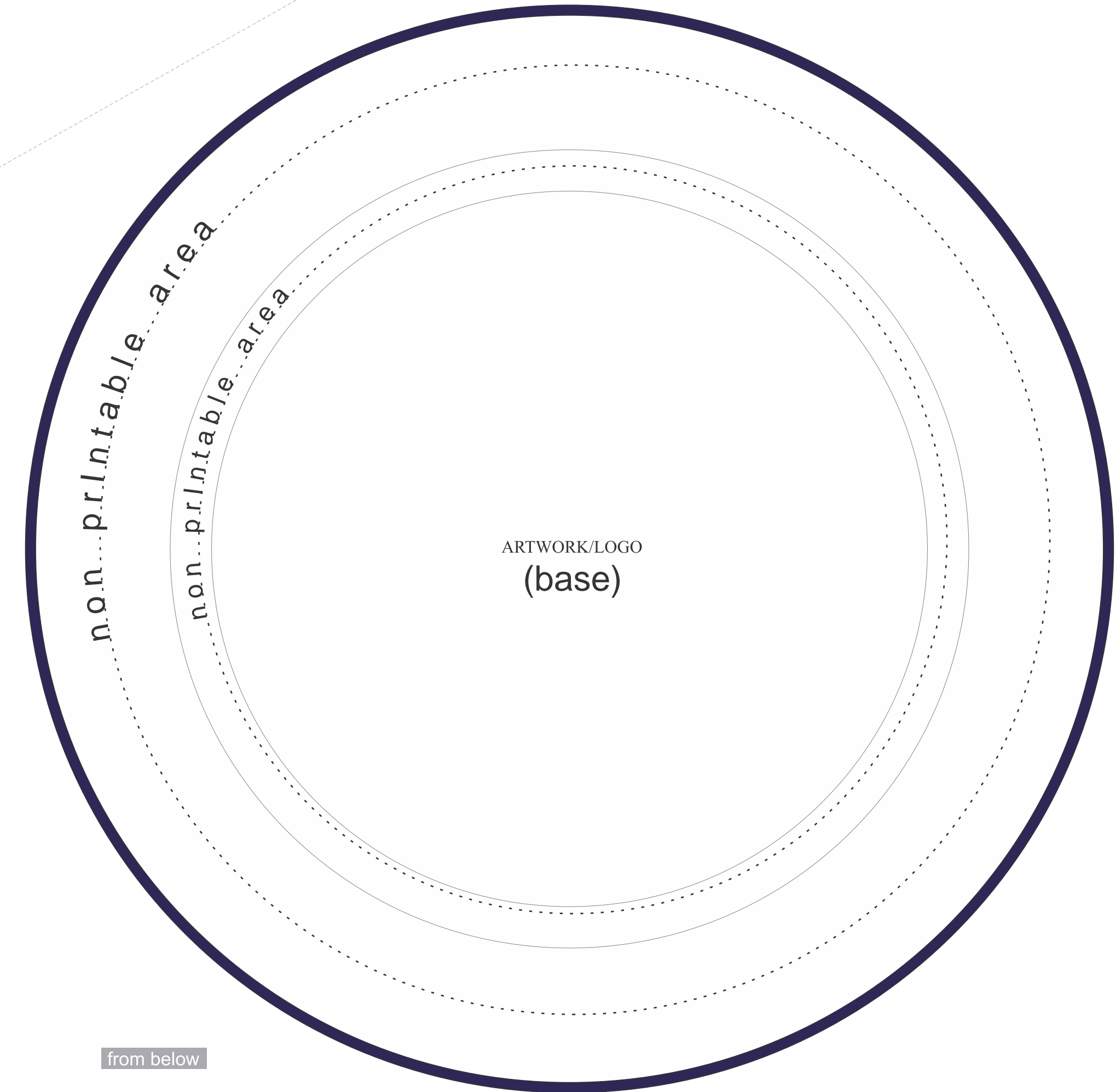

from below



YOUR  
COMPANY  
NAME

15 CM  
BOWL  
DIELINE  
scale 1:1

DIMENSIONS

height 50mm 1.96 inch  
diameter 150mm 5.90 inch

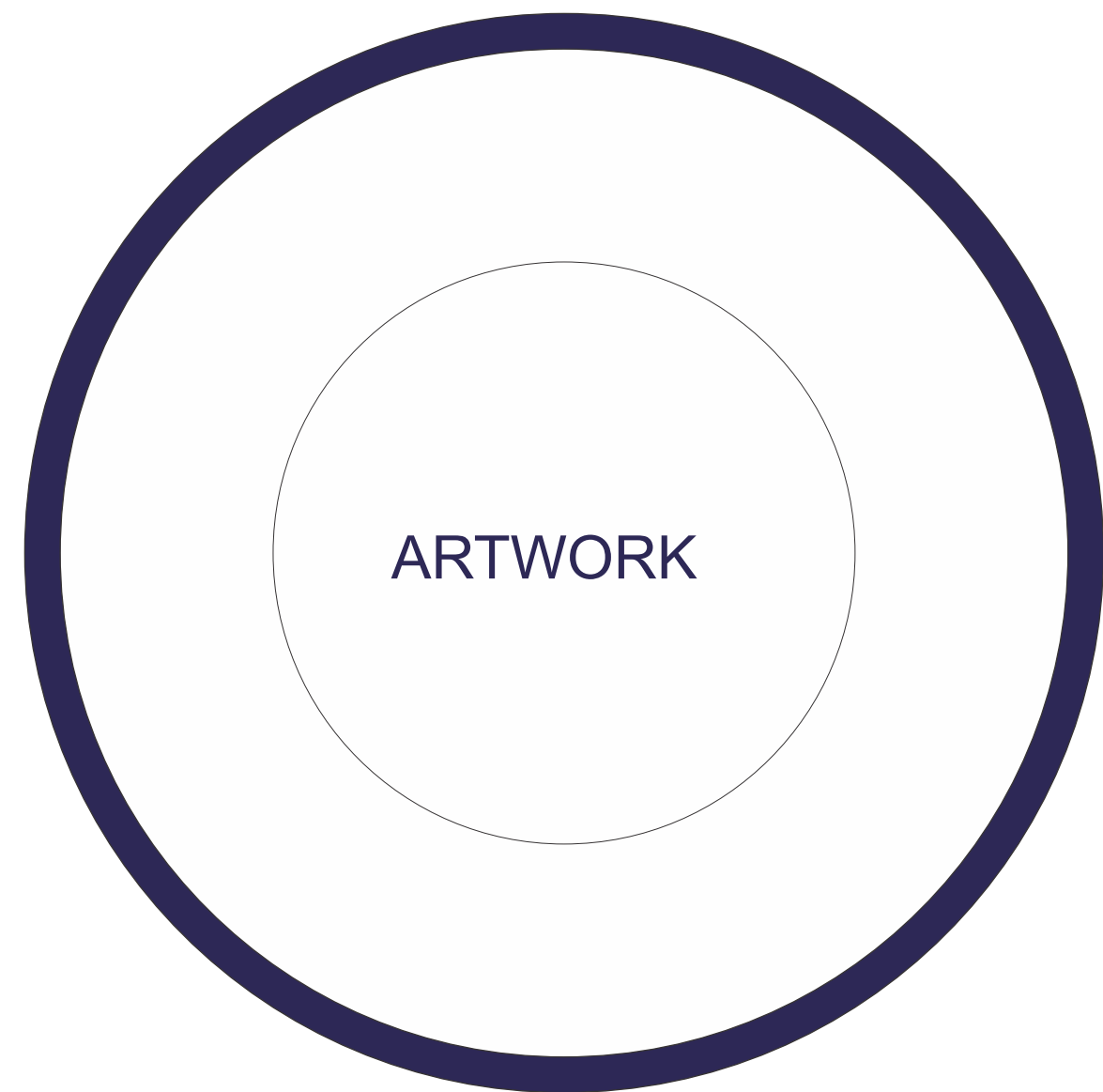

from above



X 4 sides



from below

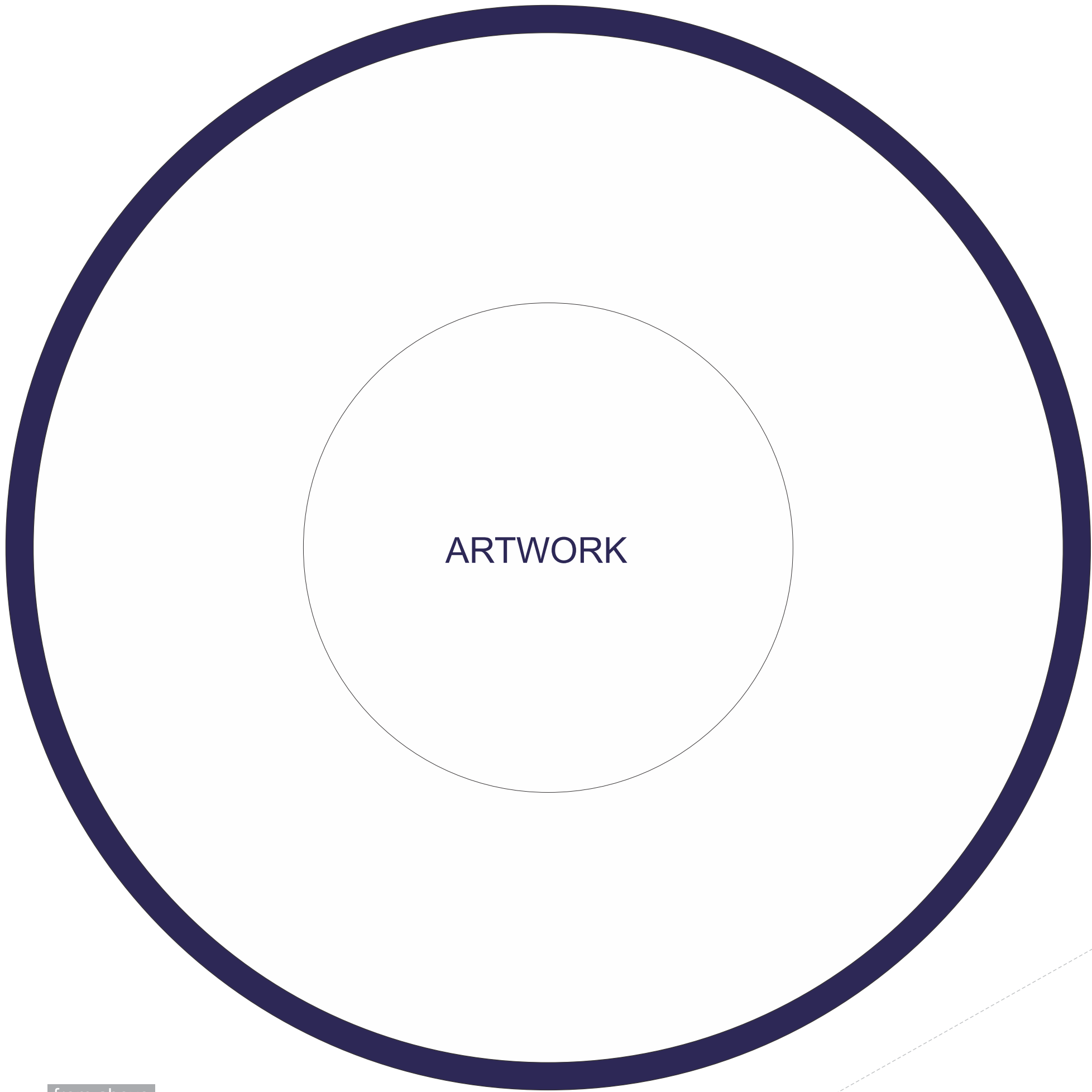

from above



ARTWORK FOR SIDES

X 4 sides

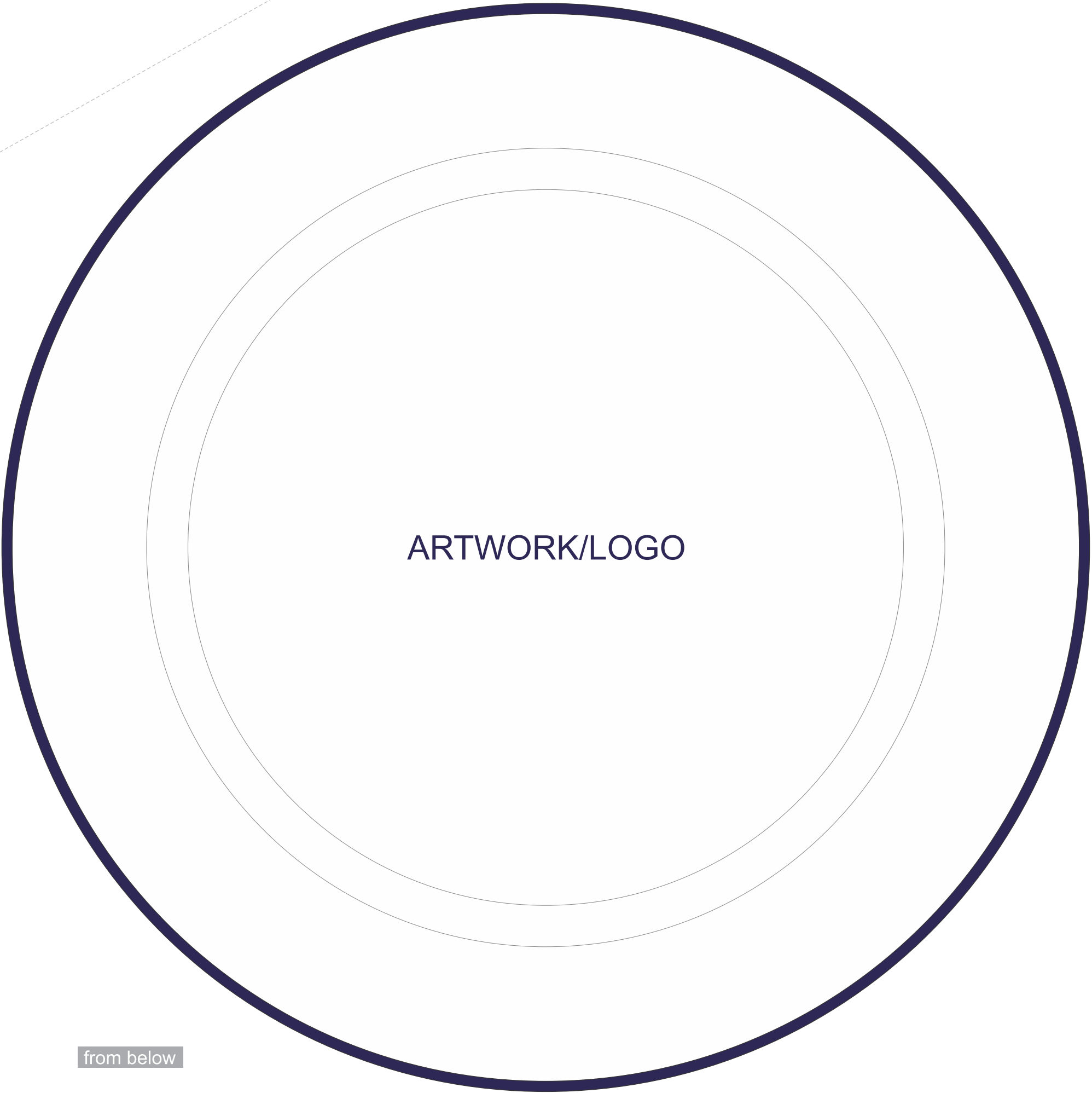

from below

YOUR COMPANY NAME

26 CM BOWL DIELINE scale 1:1

DIMENSIONS

height 68mm 2.67 inch diameter 260mm 10.2 inch





**YOUR  
COMPANY  
NAME**

**7CM  
SAUCE DISH  
DIELINE**

scale 1:1

**DIMENSIONS**

*height*    40mm    1.57 inch

*diameter*    73mm    2.87inch

**15/15**

from above

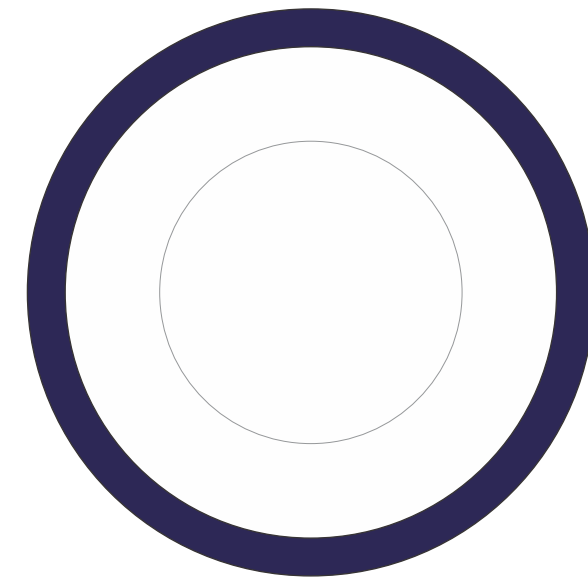

from below

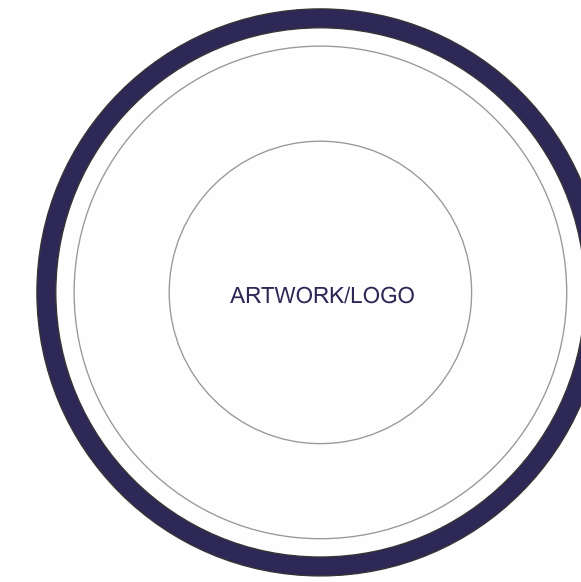

side A



side B

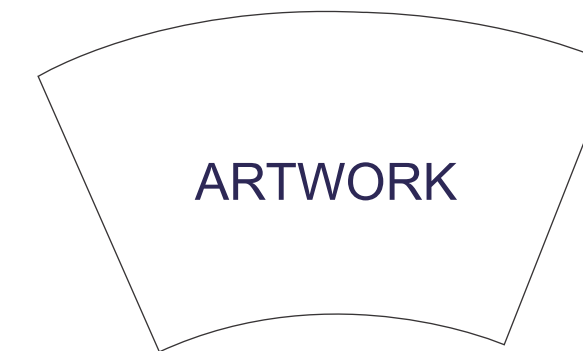



**YOUR  
COMPANY  
NAME**

**13.5CM  
CEREAL BOWL  
DIELINE**

scale 1:1

**DIMENSIONS**

*height 56mm 2.2inch*

*diameter 135mm 5.3inch*

**15/15**

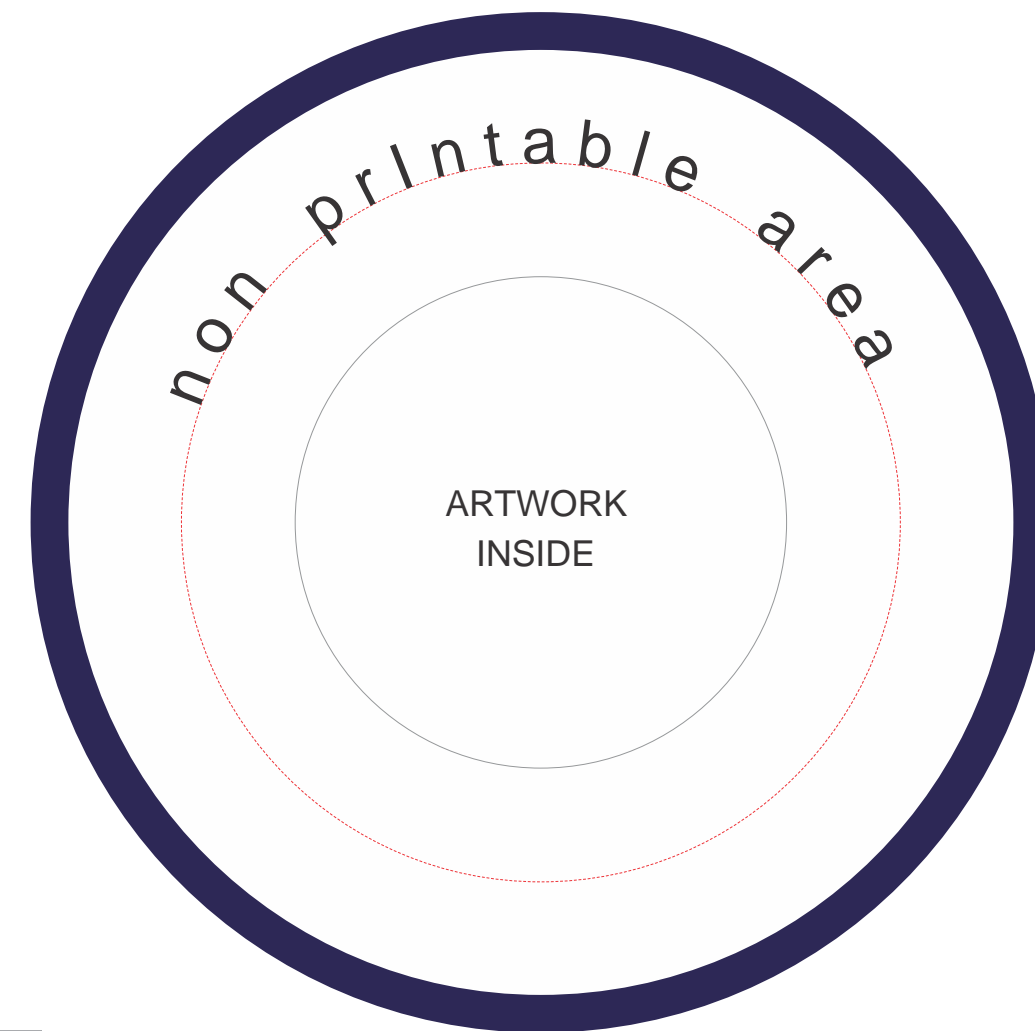

from above

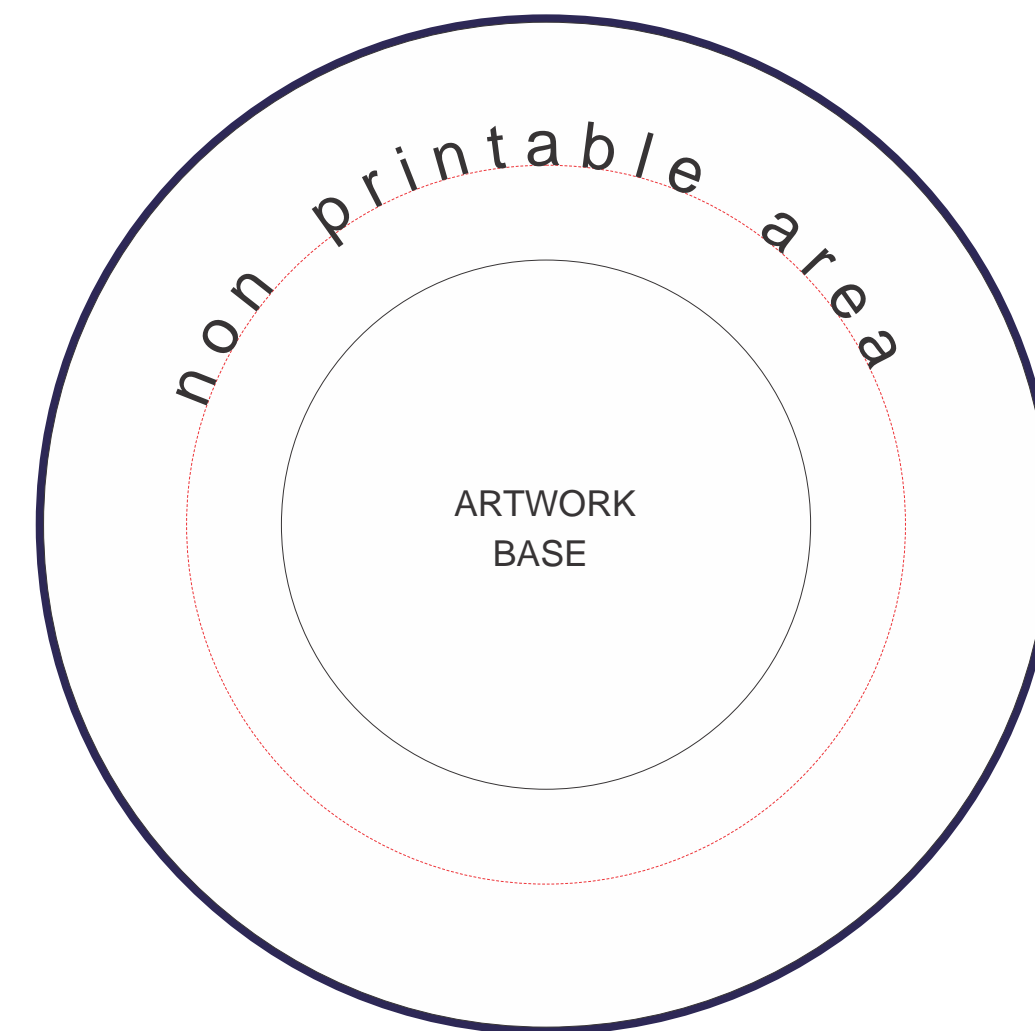

from below

